

1.0m x 50m ROLL
150gsm

Danelaw[®] LR150TT

1.0m X 50m ROLL
150gsm

- Supported and unsupported applications
- Compliance with requirements of BS 5534 and BS 5250
- UV Resistant
- Lightweight and cost-effective
- High strength to weight ratio
- Cold and warm roof applications

BATTEN GAUGE	WIND UPLIFT RESISTANCE	WIND ZONES				
		1	2	3	4	5
≤345mm	2650 Pa	✓	✓	✓	✓	✓
≤250mm	>2650 Pa	✓	✓	✓	✓	✓
≤100mm	>2650 Pa	✓	✓	✓	✓	✓

NOTE 1: Zone suitability applies only for underlays in applications where a well-sealed ceiling is present, ridge height is not greater than 15m, roof pitch is between 12.5° and 75°, site altitude is not greater than 100m, and no significant site topography is present. Other applications might require underlays with greater wind uplift resistance and it is advisable to seek professional advice.

NOTE 2: Zones 3 and 4 apply to Northern Ireland. Zone 3 applies to the Scilly Isles and Channel Islands. Zone 5 applies to the Shetland Islands.

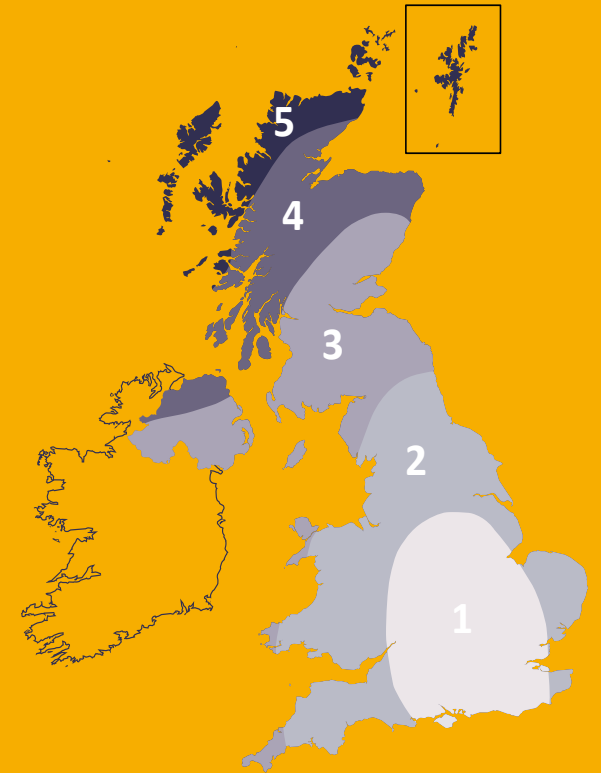

- Danelaw LR150TT has been developed for use as a low resistance (breathable) roof tile and slate underlay. It is intended for use on pitched roofs as a secondary barrier installed beneath tiles and slates. The product can be used draped unsupported over timber rafters and counter battens, or fully supported on timber sarking or rigid insulation.
- Danelaw LR150TT has an integral double tape system for effective sealing of the horizontal overlap.
- The product should be installed in accordance with the manufacturer's installation guidelines and relevant clauses in BS 5534; *Slating and tiling for pitched roofs and vertical cladding. Code of practice*, and BS 8000, *Workmanship on building sites, Code of practice for slating and tiling of roofs and walls*.
- Danelaw LR150TT will provide a secondary barrier to prevent the ingress of wind driven rain, snow and dust. It should be installed to ensure moisture in the batten cavity can drain freely down the roof and be discharged into the rainwater gutter at eaves.

CE

Hambleside Danelaw Ltd
Long March, NN11 4NR
17

Flexible sheet for underlays
Low resistance underlay for discontinuous roofing

EN 13859-1:2010
DOP: 006HDL2017-03-01 Rev 12/2020



BBA APPROVAL
INSPECTION
TESTING
CERTIFICATION
CERTIFICATE No 17/5426

See overleaf for Installation Guidance

PRODUCT CODE: DLR150TT 1.0



5060040602775

BREATHABLE ROOF TILE UNDERLAY
Danelaw LR150TT
 BREATHABLE ROOF TILE UNDERLAY

150gsm
 1.0m x 50m ROLL

Danelaw LR150TT

Danelaw LR150TT is UV resistant and can be exposed on site for a maximum period of three months. However, it is recommended that the product be protected by the outer roof covering as soon as practicably possible and in keeping with good working practice.

Danelaw LR150TT underlay should not come into contact with wet solvent or water based timber treatments. Operatives, particularly when using power tools, must prevent oil and petrol from spilling onto the surface of the underlay.

Danelaw LR150TT is a type LR underlay as defined in BS 5250, Annex H. The underlay can be installed as part of a system without ventilation, subject to the construction of a well-sealed ceiling incorporating a vapour control layer. However, this is difficult to achieve in practice and is acknowledged as not being fail safe. Therefore, it is highly recommended that the ventilation guidelines in BS 5250, *Code of practice for control of condensation in buildings* and *NHBC Standards Chapter 7.2 Pitched Roofs* are followed.

Installation Guidelines

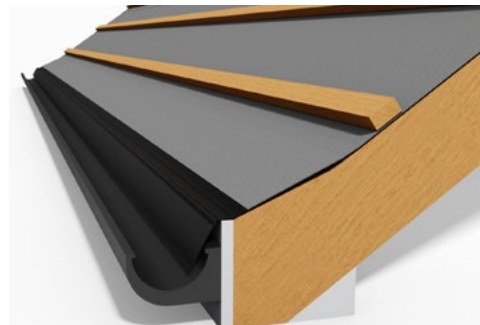

fig 1: Eaves detail

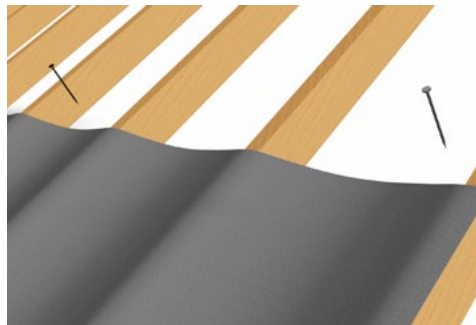

fig 2: Drape and nailing

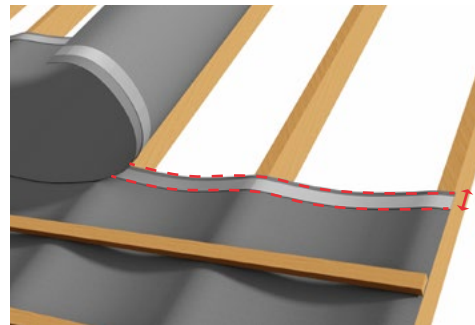

fig 3: Horizontal laps

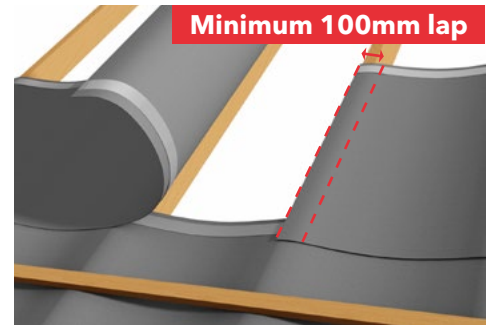

fig 4: Vertical laps

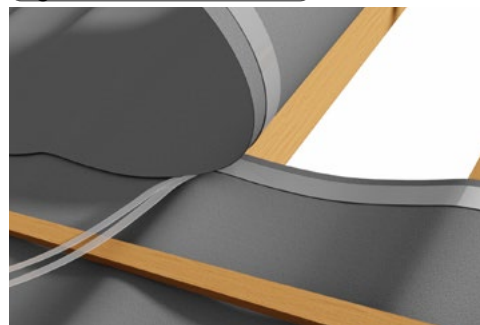

fig 5: Double integral tape

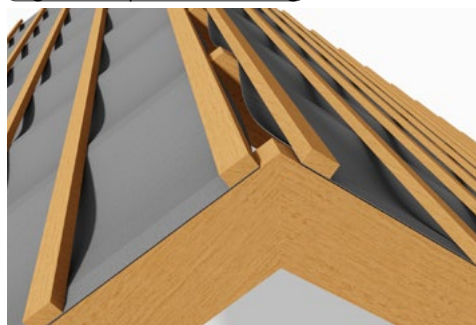

fig 6: Ridge ventilation

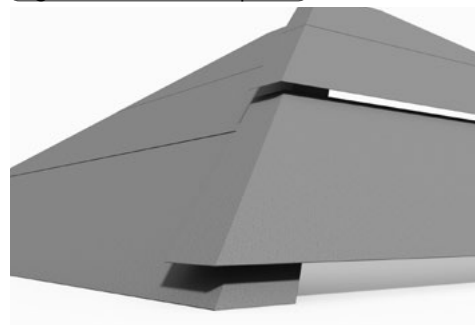

fig 7: Hip laps

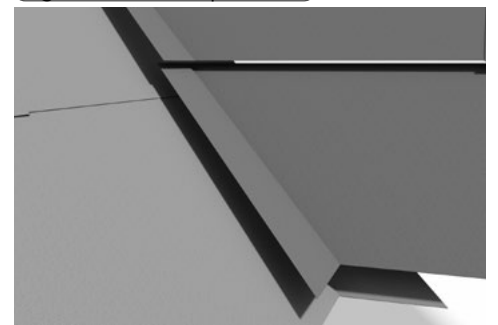

fig 8: Valley laps

1. Install Danelaw eaves support tray or a suitable UV resistant membrane (eg. BS 8747 type 5U) along the eaves with the bottom edge dressed into the rainwater gutter. The support tray ends should be lapped or clipped together, or the 5U laid over a wedge support timber fillet and lapped.
2. Lay Danelaw LR150TT printed side facing outwards, parallel to the eaves with the bottom edge overlapping the support tray (fig. 1) or 5U membrane by 150mm. The edge of the Danelaw LR150TT roof tile underlay should not be exposed to UV once the first course of tiles or slates are installed.
3. Where unsupported, the Danelaw LR150TT should be installed with a drape over timber rafters or counter battens of not less than 10mm and not greater than 15mm. It should be temporarily secured with the minimum number of clout nails above the upper overlap line at maximum 1200mm horizontal centres (fig. 2). Minimise any gaps in the horizontal laps resulting from different tautness in the underlay courses. This is important to facilitate the effective sealing of the horizontal overlap using the integral tapes. The tile or slate battens should be installed at the appropriate gauge and fixed to provide the main anchorage point for the underlay.
4. Continue laying each course of Danelaw LR150TT working up the roof pitch in the same way. Ensure the integral tape on the lower and upper layer are aligned, peel back the release paper on both layers of the underlay gradually at the same time and press the two layers together to form an effective seal (fig. 5). Continue working along the roof in this way to seal the full length of the horizontal overlap (fig. 3). Tape to tape alignment is achieved using the 150mm overlap line marked on the membrane.
5. Vertical overlaps should be a minimum of 100mm and coincide with rafter positions where the underlay is unsupported (fig. 4). The distance from fixing to the edge of the underlay should be a minimum of 50mm. Avoid vertical laps over the same rafter in consecutive courses.
6. Where ridge ventilation is not being provided, the Danelaw LR150TT should extend over the ridge and overlap the underlay on the opposite side of the roof by the required amount. When being used in conjunction with ridge ventilation, the underlay should be cut or terminated and secured to ensure that the ventilation path remains clear along the length of the ridge (fig. 6).
7. The Danelaw LR150TT should extend over any hips and overlap the underlay on the opposite side of the hip by not less than 150mm beyond the junction line (fig. 7). Alternatively, lay a strip not less than 600mm wide along the length of the hip and over the underlay on either side.
8. Where valleys occur, the Danelaw LR150TT should be laid not less than 300mm beyond the centre line of the valley on each side (fig. 8). Where a continuous length of underlay is laid up the length of the valley, it should be a minimum of 600mm wide and the underlay from either side of the valley should be mitre cut to the appropriate line to suit the valley trough installation requirements.
9. The side and top edges of Danelaw LR150TT underlay should be turned up at abutments by not less than 100mm to form a secondary water resistant barrier beneath the flashing or abutment detail.
10. At verges, the Danelaw LR150TT underlay should lap onto the outer skin of the masonry by a minimum 50mm when mortar bedding, or extend beyond the face of the gable as required when a dry fix verge system is used. The underlay should be secured to the flying rafter for an overhanging verge.
11. At all penetrations, such as soil pipes, roof windows etc., the Danelaw LR150TT underlay should be cut neatly and turned up against the penetration. For pipes etc., the underlay should be cut accurately to a ✱ shape and the flaps turned upwards and taped to minimise the risk of water ingress through the underlay.
12. Any damage to the Danelaw LR150TT underlay can be repaired by replacing damaged areas with a patch. The patch should be applied to ensure water can safely drain down the roof pitch and a water-resistant barrier is maintained. The patch can be sealed using an appropriate tape or sealant strip.
13. The integral tapes when effectively sealed provide a 150mm horizontal overlap. This size of sealed overlap is suitable for roof pitches from 12.5° to 35° and above. Please note that this does not apply to unsealed horizontal overlaps and in this instance the guidelines in BS 5534 should always be followed.

Rafter Pitch	Unsupported	Fully supported
12.5° to 14.5°	225mm	150mm
15° to 34.5°	150mm	100mm
35° and above	150mm	75mm

Essential Characteristics	Performance		Harmonised Technical Specification
	Result		
Reaction to fire [class]	E		EN 13859-1:2010 EN 13859-2:2010
Dangerous substances	none		
Flexibility at low temperatures (°C)	-40		
Water vapour transmission properties Sd [m]	0,02 (+0,040/-0,005)		
Resistance to water penetration [class]	Before artificial ageing	W1	
	After artificial ageing	W1	
Tensile strength [N/50mm]	Longitudinal	Transverse	
	Before artificial ageing	210 (+/-40)	
	After artificial ageing	180 (+/-20)	
Elongation [%]	Longitudinal	Transverse	
	Before artificial ageing	75 (+/-15)	
	After artificial ageing	50 (+/-10)	
Tear Resistance [N]	Longitudinal	Transverse	
		160 (+/-15)	